

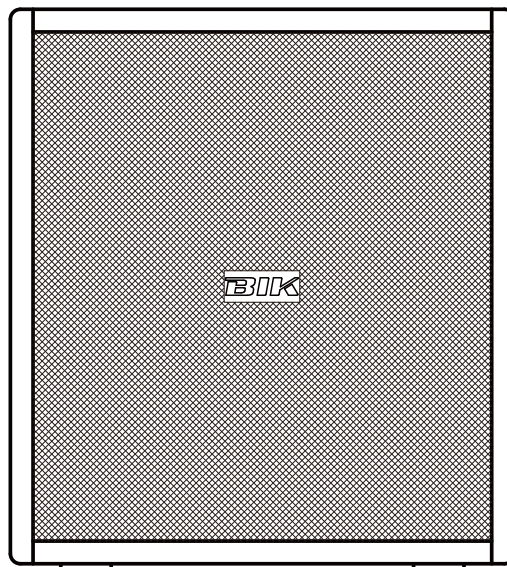

取扱説明書
OWNER'S MANUAL
使用说明书

BJ-W35A
SUB-WOOFER SYSTEM
有源重低音音箱





Thank you for purchasing our Sub-Woofers System.
Please read the owner's manual thoroughly prior to use.
Please keep the manual for future reference.

感谢您购买本公司的有源重低音音箱
为了尽快的熟悉掌握本产品的各项功能，使用前请仔细阅读本说明书。
阅读后，请注意妥善保管。

CAUTION FOR SAFETY

This "Caution for safety" shows various kinds of pictures in order to be used safely and correctly and to prevent from damaging other people, and their property. Please read with full understanding, and carefulness.

 WARNING	This shows: Using this product with disregarding cautions might call for death or injury.
 CAUTION	This shows: Using this product with disregarding cautions might call for people to be harmed and goods to be damaged.

WARNING

- Making use of this product under the circumstances that a smoke, an abnormal smell, an irregular sound coming out, it may cause a fire and an electric shock. In this case, switch off the product, and take AC plug out of the outlet right away. Bring it to the shop for repair.
- In case when water or foreign substances get into product, switch off right away, and take AC plug out of outlet, and consult with the repair shop, otherwise, it may cause a fire or an electric shock.
- Re-assembling this product is highly prohibited, otherwise, it may cause a fire or an electric shock.
- Do not take the cover out, otherwise, it may cause an electric shock. Inspection, repair should be done in the repair shop.
- This product can no way be used in the bathroom, otherwise, it may cause a fire, or an electric shock.
- Pay attention not for water to go into or get wet, or it may cause a fire or get an electric shock.
- This product can be used only with AC220V-240V, otherwise it may cause a fire or get an electric shock.
- This product is not designed for built-in installation : do not place the product in an enclosed place such as a bookcase or rack.
- Be careful for AC plug, or outlet not to get dust or to get wet, or it may cause a fire.

CAUTION

- When this product is not used for a longer period, power supply plug should be taken out of outlet.
- In case the thunder is generated near-by, take power supply plug out of outlet right away, or it may cause a fire or an electric shock.
- If this product needs to be moved, switch off first, and then take power supply plug out, or it may damage cord, and may cause a fire or an electric shock.
- Do not put this product near cooking counter or damp supply outlet, or it may cause a fire or an electric shock.
- Do not put this product on unstable desk, it may damage or injury when dropped.
- Do not leave this product for a longer period such as in the cars where all windows are shut, or place where direct sunshine hits, or it may damage each part of this product, and may cause a fire.

FUNCTION AND NAME

AMPLIFIER PANEL

- Power Switch**
- Power Inlet**
AC220V - 240V / 50Hz
- Power Indicator**
- Input (RCA Type)**
Connect to line output or sub-woofer output of amplifier.
- Line Input (XLR Type)**
Connect to line output of amplifier.
- Line Output (XLR Type)**
Connect to line input of extra sub-woofer.
- Volume Control**
To adjust sound level.
- Low Pass Filter Control**
To adjust cut-off frequency.

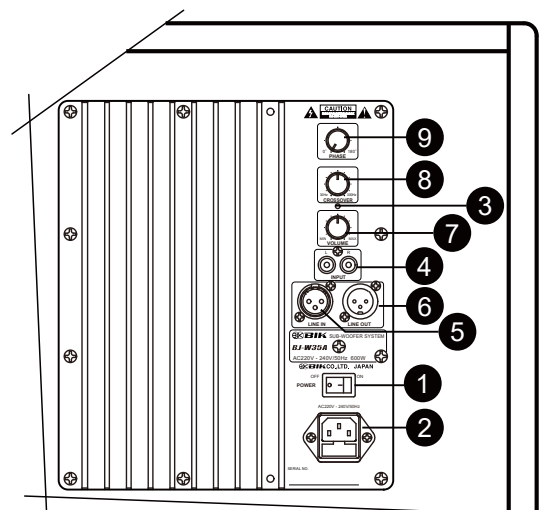
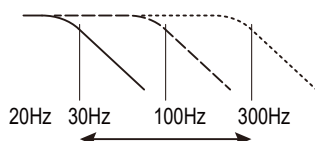

- Phase Control**
To adjust phase to 180° from 0°

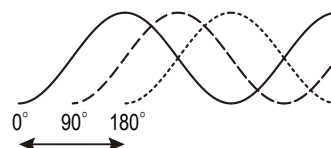

CONNECTION

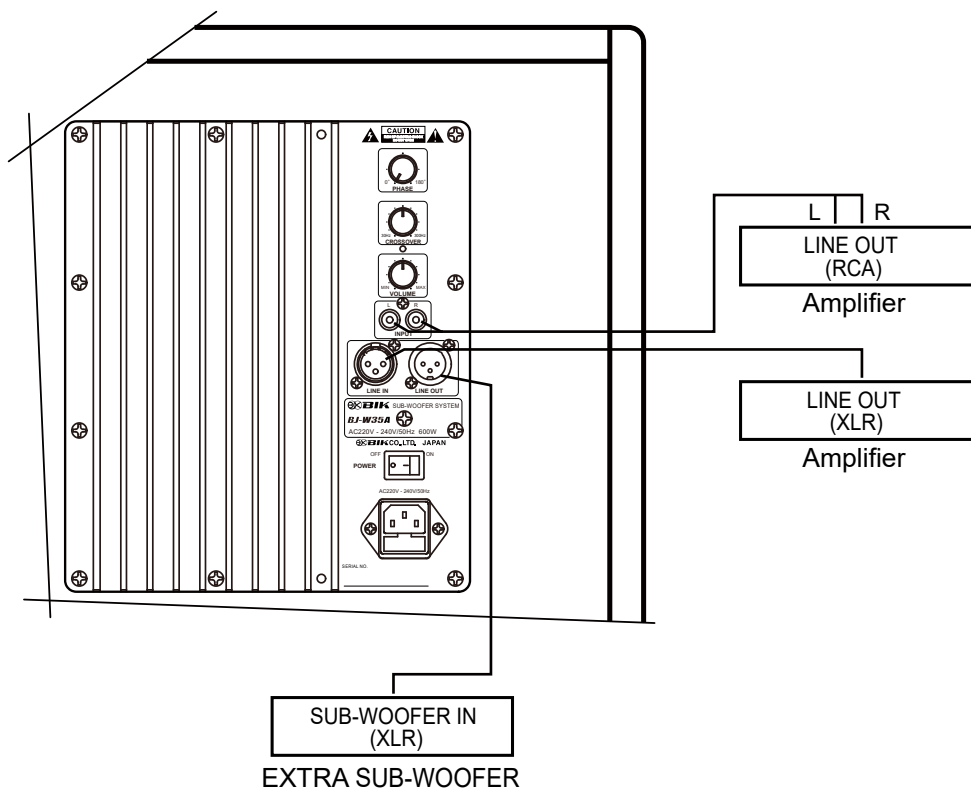

ANY TROUBLES?

Any troubles? Please check the followings. Your careless mistakes seem to be troubles.
Consult with your dealers in case any troubles can not be solved after checking the followings.

Trouble	Cause	Remedy
Can not power on	● The power cord is not connected.	● Connect the power cord to AC outlet.
Power ON, but no sound.	● Volume is set at minimum position. ● Input signal wires in broken or not connected Correctly.	● Set volume at your requited position. ● Connect the input signal wire correctly.

SPECIFICATIONS

Amplifier

Maximum Output Power 350W / 8Ω
 Frequency Response 20Hz - 300Hz
 Cut-off frequency Control 30Hz - 300Hz
 Phase control 0° - 180°

Speaker

Woofer 12" Cone Type

Power Supply, Others

Power Voltage 220V - 240V
 Power Consumption 400W
 Dimensions (W X H X D) 400 X 445 X 450mm
 Weight 27.55 Kg

Accessories

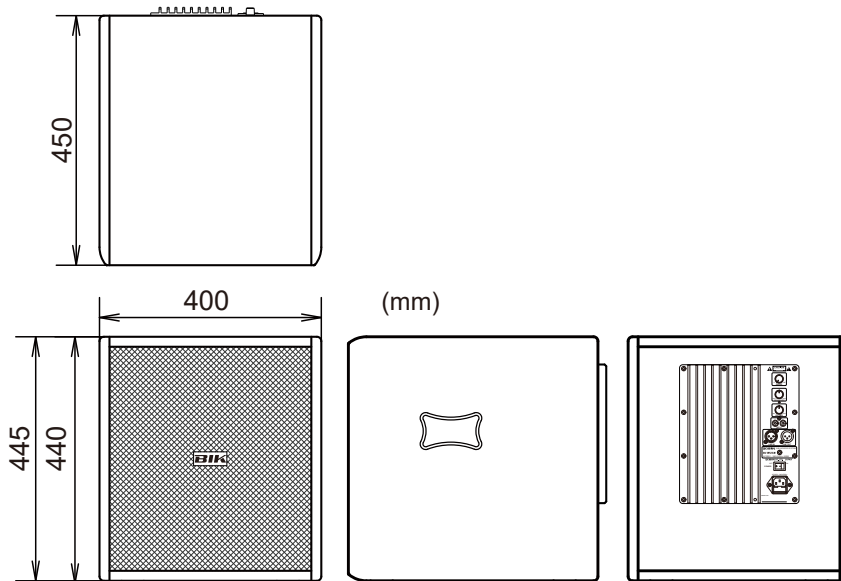

Owner's manual 1
 Power cord 1

● Design and specifications subject to change without notice.



安全注意事项

安全注意事项是为了安全正确使用本商品、防止给自己及他人带来财产损害。以下用图标的形式加以注明。请仔细阅读本文。

 警告	警告 无视或误用会有造成人身事故的可能性。
 注意	注意 无视或误用会有造成人身伤残、或对财产损坏的可能性。

警告

- 在使用时，如果有冒烟、异味、异音等异常现象发生、为避免发生火灾、触电现象等、请立即切断本机电源、然后拔下AC电源插头。确认没有再冒烟后、到贩卖店进行修理。
- 在使用时如有水或异物等混入机体内、首先切断机体电源、然后拔下电源插头。请尽快与经销商联系、进行修理。
- 在未进行维修的状态下使用、会引起火灾、触电现象等问题。
- 请勿分解、改装本机器、会引起火灾、触电、故障等现象。绝对不可以打开本机器的外壳、会引起触电事故。内部的检查、修理等请委托经销商。
- 请勿在浴室内使用、会引起火灾、触电等现象。
- 请防止机器进水或使机器受潮、会引起火灾、触电等现象。
- 电源插头不要插入电压（AC220V - AC240V）以外的电源上。有造成火灾、触电的危险。
- 请不要用带有灰尘、或带有湿气的插头和插座、会引起火灾等现象。

注意

- 旅行等长时间不使用时、为了安全请务必拔下插头。
- 如近距离内有雷电现象时、请拔下电源插头，由于雷电原因，会引起火灾、触电、故障等现象。
- 移动时首先关闭电源开关、然后务必拔下电源插头。
- 请勿放置在灶台、加湿器及有油烟、雾气的地方。会引起火灾、触电等现象。
- 请勿放置在不安稳的桌上、或倾斜的地方。会容易掉落、翻倒而造成损坏、损伤等现象。
- 请勿放置在紧闭车窗的汽车内、或阳光直射及高温的地方。以免造成零部件的损坏、而引起火灾。

各部分的功能及名称

功率放大器面板

- 1 电源开关**
- 2 电源线插座**
电源电压 AC 220 - 240V / 50Hz
- 3 电源显示灯**
- 4 音频信号输入端子 (RCA)**
连接合并功放的低音信号输出
- 5 音频信号输入端子 (XLR)**
连接前级效果器的低音信号输出
- 6 音频信号输出端子 (XLR)**
外接有源低音箱 LINE INPUT
- 7 音量调节**
- 8 低通滤波调节**
滤波的遮断频率调节

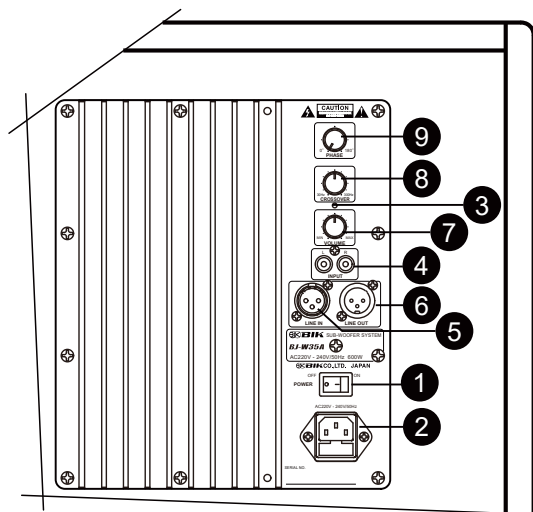
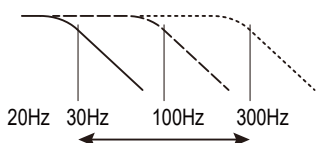

- 9 相位调节**
信号相位 0° -180° 可变调节。

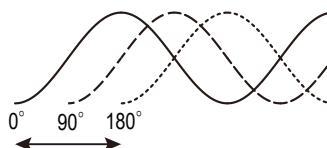

连接方法

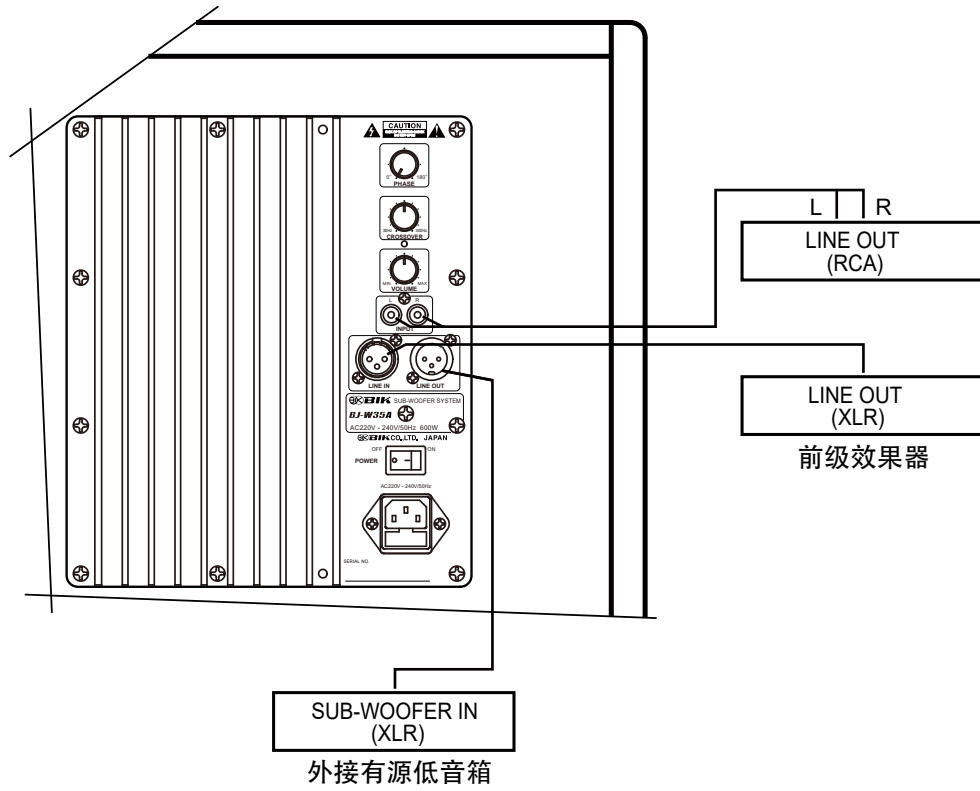

故障分析处理

如感觉有故障根据以下方法检查。偶尔会有因为操作错误而误认为是故障的现象。根据以下方法检查也不能解决的情况下，请直接联系贩卖店。

故障症状	原因	解决方法
没有电源	● 电源线没有插好。	● 请插好电源插头，将旋钮调整到适当位置。
电源接通但是没有声音。	● 音乐旋钮或麦克旋钮设定在最小的位置。 ● 输入信号选择不正确。	● 调节适当的音量。 ● 请选择正确的音源信号。

产品规格

功能放大器部分

最大输出 350W / 8Ω
 频率特性 20Hz - 300Hz
 遮断频率连续可变调节 30Hz - 300Hz
 相位连续可变调节 0° - 180°

扬声器部分

低音单元 12寸圆锥形

电源及其他

电源电压 220V - 240V
 电源功耗 400W
 外形尺寸 (长×高×宽) 400 X 445 X 450mm
 净重 27.55kg

附属品

使用说明书 (1个)
 电源连接线 (1个)

● 日后为提高改善产品效果功能而变更规格时不另行公告。

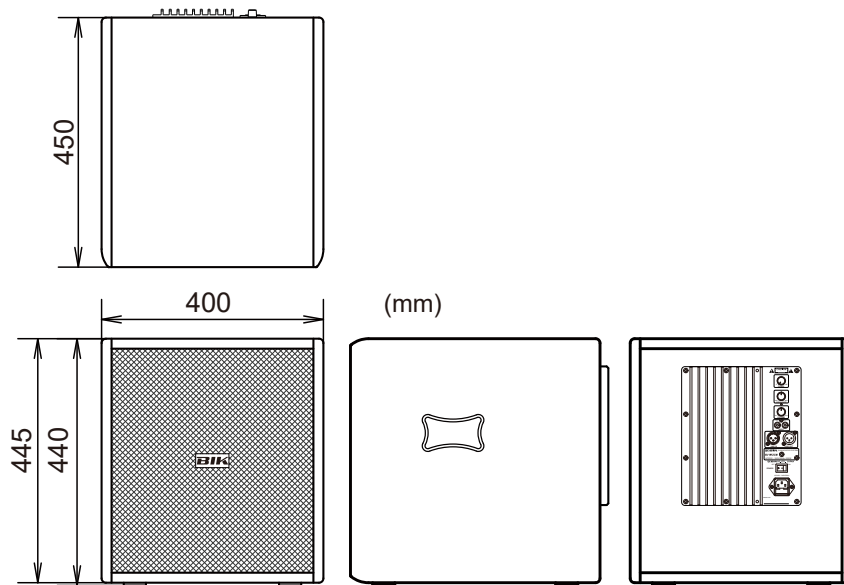



株式会社 ビーアイケー
〒343-0856 埼玉県越谷市谷中町3丁目17-1

BIK CO.,LTD.
3-17-1 YANAKA-CHO. KOSHIGAYA-SHI. SAITAMA-KEN. 343-0856 JAPAN
TEL. +81-48-969-6533 FAX. +81-48-969-6556
URL. <http://www.bik-audio.com> Email. best-sound@bik-coltd.jp